

Hardwyn

Since 1965
Perfection Redefined

KITCHEN & WARDROBE HARDWARE SOLUTION

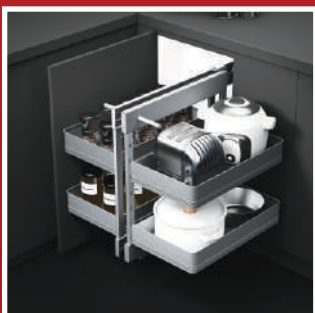

ABOUT US

60 years of redefining perfection.

Hardwyn is a trusted manufacturer of architectural hardware, kitchen fittings, and glass solutions, catering to both residential and commercial infrastructure needs. Our commitment to excellence is driven by a customer-centric approach and an unwavering focus on delivering world-class quality. Through rigorous testing and continuous R&D, we have established ourselves as a benchmark in the industry. This dedication has earned us a strong reputation for innovation, reliability, and performance. Our global presence is a result of our relentless efforts to build an integrated global supply chain and a reliable distribution network.

A wide-reaching network of dealers and distributors ensures seamless customer support and service. At Hardwyn, sustainability is at the heart of our operations. We are proud to adopt environmentally responsible manufacturing practices as a core part of our vision. As we continue to play an active role in the nation's development,

Hardwyn remains the preferred partner for residential and commercial projects alike — delivering quality, trust, and innovation at every step.

**WARM REGARDS
S.S. SAYAL (CHAIRMAN)
HARDWYN INDIA LTD.**

INDEX

Kitchen Accessories



VERTINO GLASS SERIES:- 05-09	Pages
Glass Motion Drives (Plain Basket)	06
Cutlery Basket	06
Universal Magic Corner	06
Glass Bottle Pull Out	07
Glass Magic Corner (Universal)	07
Tier Glass Pantry Pull Out	08
Glass Soft Closing Grain Trolley	09
Glass Detergent Pull Out	09
Glass Tall Unit Swinga Soft-Close	09

SANTINO S.S. SERIES:- 10-15

S.S. Motion Drives (Plain Basket)	12
Cutlery Basket	12
S.S. Bottle Pull Out	13
Universal Magic Corner (Soft-Close)	13
Tier S.S. Pantry Pull Out	14
S.S. Soft Closing Grain Trolley	15
S.S. Multi-Functional Detergent Rack	15
S.S. Tall Unit Swinga Soft-Close	15

CHARCOAL SERIES:- 16-17

Charcoal Pantry Pull Out	16
Charcoal Bottle Pull Out	16
Charcoal S-Carousel (Left/Right)	17
Charcoal Universal Magic Corner	17

LENIA WIRE SERIES:- 18-24

Plain Basket, Perforated Cutlery Basket	20
Cup, Plate, Thali Partition Grain trolley	21
Bottle Pull Out, Detergent Rack	22
Pantry Pull out, Tall Unit, Magic Corner	23
Cylinder Trolley, Use-me Shutter,	24
Bin Holder, 3/4-Carousel 270°	24

ACCESSORIES:- 25-31

Partitions	25
Corner Solution	27
Casario, Dish Rack, Waste Bin S.S.	28
Waste Bin PVC, Elevator System	29
Rolling Shutter	30
Kitchen Hanging	31

Kitchen Hardware



Kitchen Hardware:- 32-40	Pages
Wooden Cutlery, Slim Box	32
Duro Box	33
Bi Fold Up Lifter, Gas Pump	34
Single Up Lifter,	34
Hinges	35
Slides	36
Telescopic Channel	37
Profiles	38

Wardrobes Accessories



Wardrobe White Accessories	40
Wardrobe Mocha Accessories	45
Wardrobe Grey Accessories	49

Sliding Fittings

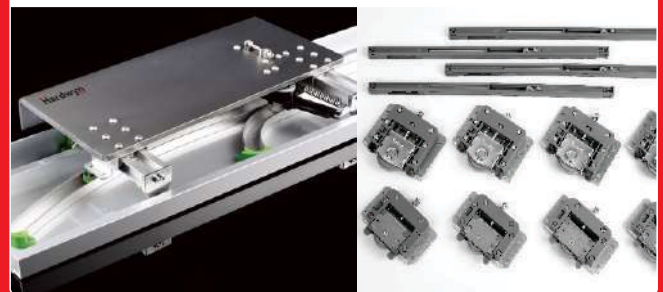

In-line Wardrobe Fitting	54
External Soft-Close, Brush Roller	55



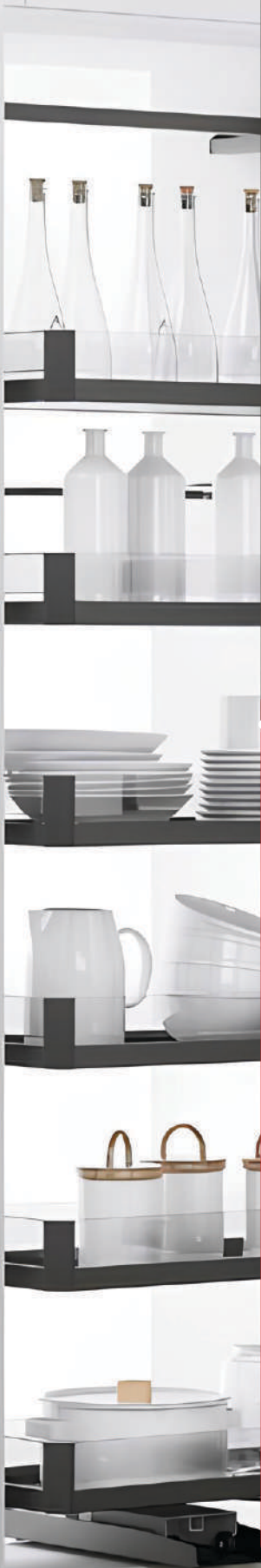

Vertino Glass Series

Vertino Basket is made of high-quality Stainless Steel and armored glass. Adopted with German Technology and Passed through European standard GS-60000 test, Slide still can be used smoothly for its long services.



Glass Motion Drives. (Plain Basket)



Product Advantages

- The most utilitarian solution of kitchen storage
- Standard configuration damping track, sliding smoothly, silent
- Plastic accessories is ABS material
- Side panel in toughened glass
- Items at a glance, within easy reach
- Channel inclusive
- Weight capacity upto 45 kg

Available Size

Carcass size (outer to outer)	Product Specification		Article No.	Price
	(mm)	(inch)		
450 mm	414 x 500 x 130	15 x 20 x 4	HKVD.11.450.130	₹ 4505/-
450 mm	414 x 500 x 170	15 x 20 x 6	HKVD.11.450.170	₹ 4620/-
600 mm	564 x 500 x 130	21 x 20 x 4	HKVD.11.600.130	₹ 4935/-
600 mm	564 x 500 x 170	21 x 20 x 6	HKVD.11.600.170	₹ 5095/-
750 mm	714 x 500 x 130	28 x 20 x 4	HKVD.11.750.130	₹ 5545/-
750 mm	714 x 500 x 170	28 x 20 x 6	HKVD.11.750.170	₹ 5660/-
900 mm	864 x 500 x 130	32 x 20 x 4	HKVD.11.900.130	₹ 6145/-
900 mm	864 x 500 x 170	32 x 20 x 6	HKVD.11.900.170	₹ 6250/-

Cutlery Basket



Available Size

Carcass size (outer to outer)	Product Specification		Article No.	Price
	(mm)	(Inch)		
450mm	414 x 500 x 130	15x20x4	HKVCB.11.450	₹ 7090/-
600mm	564 x 500 x 130	21x20x4	HKVCB.11.600	₹ 9650/-
750mm	714 x 500 x 130	28x20x4	HKVCB.11.750	₹ 11500/-
900mm	864 x 500 x 130	32x20x4	HKVCB.11.900	₹ 12760/-

Note : All above motion drives / cutlery basket are only Available with hydraw channels.

Article No. HKHDPB MRP: Rs. 2420/- (with all fitments)



2- Tier Glass Bottle Pull Out



Product Advantages

- Easy to install
- Standard Configuration damping track, sliding Smoothly silent
- Plastic accessories in ABS material
- Side panel is toughened glass
- Can be used to keep oil, chopping board etc
- 150mm size is Under mounted (Soft close).
- 200mm, 250mm,300mm size is Side mounted (Soft close).

Available Size

Carcass size (outer to outer)	Product Specification (mm)	Article No.	Price
150 mm	110 x 500 x 490	HKVBP.14.150	₹ 9890/-
200 mm	155 x 500 x 490	HKVBP.14.200	₹ 10530/-
250 mm	200 x 500 x 490	HKVBP.14.250	₹ 11550/-
300 mm	250 x 500 x 490	HKVBP.14.300	₹ 12550/-

3- Tier Glass Bottle Pull Out



Product Advantages

- Easy to install
- Standard Configuration damping track, sliding Smoothly silent
- Plastic accessories in ABS material
- Side panel is toughened glass
- Can be used to keep oil, chopping board etc
- 300mm,450mm size is Under mounted (Soft close).

Available Size

Carcass size (outer to outer)	Product Specification (mm)	Article No.	Price
300 mm	250 x 500 x 490	HKVBP.15.300	₹ 12680/-
450 mm	400 x 500 x 490	HKVBP.15.450	₹ 13940/-

Glass Magic Corner Soft-Close (Universal)



Product Advantages

- Added environmental anti-slip mat
- Standard Configuration damping track, sliding smoothly silent
- Load Bearing Capacity 20 kg, 5 kg per basket Storage all places
- Side Panel in toughened glass
- A new fast loading structure, convenience to install and adjustment

Available Size

Carcass size (outer to outer)	Product Specification (mm)	Article No.	Price
1050-1100 mm	860-960 x 510 x 560	HKVMC.16.900(U)	₹ 37500/-

6- Tier Glass Pantry Pull Out



Product Advantages

- Easy to install
- Added environmental anti-slip mat
- 12 Baskets, Bearing 80 kg.
- Huge Storage Space
- All Basket are framed with Toughened Glass
- Stored Items

Available Size

Carcass size (outer to outer)	Product Specification (mm)	Article No.	Price
450 mm	405x500x(1780Above)	HKVPP.17.450(6)	₹ 34650/-
600 mm	555x500x(1780Above)	HKVPP.17.600(6)	₹ 39690/-

4- Tier Glass Pantry Pull Out



Product Advantages

- Added environmental anti-slip mat
- 8 Baskets, Bearing 50 kg.
- Huge Storage Space
- All Basket are framed with Toughened Glass
- Can save 60% space, makes your kitchen more comfortable

Available Size

Carcass size (outer to outer)	Product Specification (mm)	Article No.	Price
450 mm	405x500x(1180Above)	HKVPP.17.450(4)	₹ 32130/-
600 mm	555x500x(1180Above)	HKVPP.17.600(4)	₹ 34650/-

2- Tier Glass Pantry Pull Out



Product Advantages

- Easy to install
- Added environmental anti-slip mat
- 4 Baskets, Load Bearing 30 kg.
- Huge Storage Space
- All Basket are framed with Toughened Glass
- All items are easily accessible

Available Size

Carcass size (outer to outer)	Product Specification (mm)	Article No.	Price
450 mm	405 x 500 x (600-Above)	HKVPP.17.450(2)	₹ 18375/-
600 mm	555 x 500 x (600-Above)	HKVPP.17.600(2)	₹ 19425/-

Glass Soft Closing Grain Trolley



Product Advantages

- Easy to install
- Standard Configuration damping track, sliding smoothly silent
- Bearing 30 kg.
- Plastic accessories is ABS material
- Trolley Frame in toughened glass
- Supported with Metal Frame

Available Size

Carcass size (outer to outer)	Product Specification (mm)	(Inch)	Article No.	Price
450 mm	414 x 450 x 490	15x18	HKVGT.19.450	₹ 9820/-
600 mm	564 x 450 x 490	21x18	HKVGT.19.600	₹ 11025/-

Soft Close Glass Detergent Pull Out



Product Advantages

- Easy to install
- Standard Configuration damping track, sliding smoothly silent
- Plastic accessories is ABS material
- Basket is toughened glass

Available Size

Carcass size (outer to outer)	Product Specification (mm)	Article No.	Price
.....	215 x 450 x 450	HKVDR.20.450	₹ 8665/-

6-Tier Glass Tall Unit Swinga Soft-Close



Product Advantages

- Add environmental anti-slip mat
- 6 Baskets, Bearing 80 kg.
- Storage space is huge, installation is simple
- Side Panel in toughened glass
- Can save 60% space, make your kitchen more spacious

Available Size

Carcass size (outer to outer)	Product Specification (mm)	Article No.	Price
450 mm	350 x 500 x (1780-2080)	HKVPS.18.400(6)	₹ 46095/-





Santino Stainless Steel Series

Santino Basket is made of high-quality Stainless Steel

Adopted with German Technology and Passed through

European Standard GS-60000 test, Slide still can be

used smoothly for its long services.

S.S Motion Drives (Plain Basket)



Product Advantages

- Easy to install
- Item at a glance, within easy reach
- Standard Configuration damping track, sliding smoothly silent
- Plastic accessories is ABS material
- The lateral plate is made of Stainless Steel wire drawing process
- Weight capacity upto 45 kg

Available Size

Carcass size (outer to outer)	Product Specification		Article No.	Price
	(mm)	(inch)		
450 mm	414 x 500 x 130	15 x 20 x 4	HKSD.01.450.130	₹ 2840/-
450 mm	414 x 500 x 170	15 x 20 x 6	HKSD.01.450.170	₹ 3130/-
500 mm	464 x 500 x 130	17 x 20 x 4	HKSD.01.500.130	₹ 3420/-
500 mm	464 x 500 x 170	17 x 20 x 6	HKSD.01.500.170	₹ 3710/-
550 mm	514 x 500 x 130	19 x 20 x 4	HKSD.01.550.130	₹ 3465/-
550 mm	514 x 500 x 170	19 x 20 x 6	HKSD.01.550.170	₹ 3740/-
600 mm	564 x 500 x 130	21 x 20 x 4	HKSD.01.600.130	₹ 3465/-
600 mm	564 x 500 x 170	21 x 20 x 6	HKSD.01.600.170	₹ 3740/-
750 mm	714 x 500 x 130	28 x 20 x 4	HKSD.01.750.130	₹ 5170/-
750 mm	714 x 500 x 170	28 x 20 x 6	HKSD.01.750.170	₹ 5435/-
900 mm	864 x 500 x 130	32 x 20 x 4	HKSD.01.900.130	₹ 5740/-
900 mm	864 x 500 x 170	32 x 20 x 6	HKSD.01.900.170	₹ 6030/-

Cutlery Basket



Available Size

Carcass size (outer to outer)	Product Specification		Article No.	Price
	(mm)	(inch)		
450 mm	414x500x130	15x20x4	HKSCB.01.450	₹ 6520/-
500 mm	464x500x130	17x20x4	HKSCB.01.500	₹ 7105/-
550 mm	514x500x130	19x20x4	HKSCB.01.550	₹ 7830/-
600 mm	564x500x130	21x20x4	HKSCB.01.600	₹ 8550/-
750 mm	714x500x130	28x20x4	HKSCB.01.750	₹ 11450/-
900 mm	864x500x130	32x20x4	HKSCB.01.900	₹ 14360/-

Note : All above motion drives / cutlery basket are only Available with hydraw channels.

Article No. HKHDPB MRP: Rs. 2420/- (with all fitments)

2- Tier S.S. Bottle Pull Out



Product Advantages

- 9.5 Easy to install
- Standard Configuration damping track, sliding smoothly silent
- Can be used to keep oil, chopping board.
- 150mm Size is under Mounted (Soft Close)
- 200mm 250mm, 300mm Size is Side Mounted (Soft Close)

Available Size

Carcass size (outer to outer)	Product Specification (mm)	Article No.	Price
150 mm	110 x 500 x 490	HKSBP.04.150	₹ 7635/-
200 mm	155 x 500 x 490	HKSBP.04.200	₹ 8400/-
250 mm	200 x 500 x 490	HKSBP.04.250	₹ 9170/-
300 mm	250 x 500 x 490	HKSBP.04.300	₹ 10300/-

3- Tier S.S. Bottle Pull Out



Product Advantages

- Easy to install
- Standard Configuration damping track, sliding smoothly silent
- Plastic accessories is ABS material
- Can be used to keep oil, chopping board.
- 300mm 450mm Size is Under Mounted (Soft Close)

Available Size

Carcass size (outer to outer)	Product Specification (mm)	Article No.	Price
300 mm	250 x 500 x 490	HKSBP.05.300	₹ 10930/-
450 mm	400 x 500 x 490	HKSBP.05.450	₹ 13745/-

Universal Magic Corner (Soft-Close)



Available Size

Carcass size (outer to outer)	Product Specification (mm)	Door width (mm)	Article No.	Price
800-900 mm	650 x 455 x 590	≥ 400	HKSMC.06.900(U)	₹ 32500/-

Installation Video Link:

<https://youtu.be/-fhPupMwF4g>

6- Tier S.S. Pantry Pull Out



Product Advantages

- Easy to install
- Added environmental anti-slip mat
- 12 Baskets, Bearing 80 kg.
- Huge Storage Space
- The baskets is easy to move and clean
- All items are easy to easily accessible

Available Size

Carcass size (outer to outer)	Product Specification (mm)	Article No.	Price
450 mm	405 x 500 x (1780Above)	HKSP.07.450(6)	₹ 31790/-
600 mm	555 x 500 x (1780Above)	HKSP.07.600(6)	₹ 37730/-

4 Tier S.S. Pantry Pull Out



Product Advantages

- Add environmental anti-slip mat
- 8 Baskets, Bearing 50 kg.
- Huge Storage Space
- Can save 60% space, make your kitchen more comfortable

Available Size

Carcass size (outer to outer)	Product Specification (mm)	Article No.	Price
450 mm	405x500x(1180Above)	HKSP.07.450(4)	₹ 28325/-
600 mm	555x500x(1180Above)	HKSP.07.600(4)	₹ 31955/-

2- Tier S.S. Pantry Pull Out



Product Advantages

- Easy to install
- Add environmental anti-slip mat
- 4 Baskets, Bearing 30 kg.
- Huge Storage Space
- All items are easy to reach

Available Size

Carcass size (outer to outer)	Product Specification (mm)	Article No.	Price
450 mm	405 x 500 x (600-Above)	HKSP.07.450(2)	₹ 15235/-
600 mm	555 x 500 x (600-Above)	HKSP.07.600(2)	₹ 17030/-

S.S. Soft Closing Grain Trolley

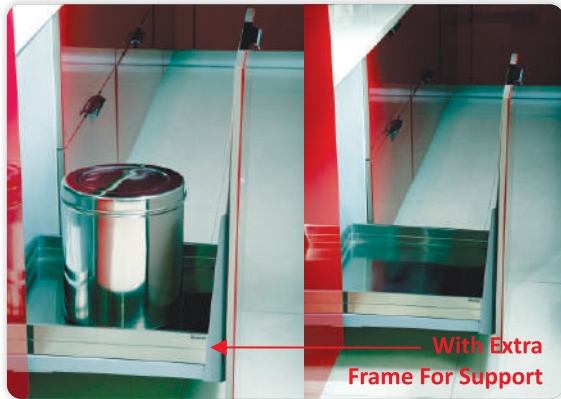

Product Advantages

- Easy to install
- Standard Configuration damping track, sliding smoothly silent
- Bearing 30 kg.
- Plastic accessories is ABS material
- **Supported with Metal Frame**

Available Size

Carcass size (outer to outer)	Product Specification		Article No.	Price
	(mm)	(inch)		
450 mm	414 x 450 x 490	15 x 18	HKSGT.09.450	₹ 9360/-
500 mm	464 x 450 x 490	17 x 18	HKSGT.09.500	₹ 10065/-
600 mm	564 x 450 x 490	21 x 18	HKSGT.09.600	₹ 10760/-

S.S Multi- Functional Detergent Rack



Product Advantages

- Easy to install
- Standard Configuration damping track, sliding smoothly silent
- Plastic accessories is ABS material

Available Size

Carcass size (outer to outer)	Product Specification (mm)	Article No.	Price
.....	215 x 450 x 450	HKSDR.10.450	₹ 8230/-

6- Tier S.S. Tall Unit Swinga Soft-Close



Product Advantages

- Added environmental anti-slip mat
- 6 Baskets, Bearing 80 kg.
- Storage space is huge, installation is simple
- Can save 60% space, make your kitchen more spacious

Available Size

Carcass size (outer to outer)	Product Specification (mm)	Article No.	Price
450 mm	350 x 500 x (1780-2080)	HKSPS.08.400(6)	₹ 40480/-



CHARCOAL SERIES

6-Tier Charcoal Pantry Pull Out



Product Advantages

- Easy to install
- Added environmental anti-slip mat
- 12 Baskets, Bearing 80 kg.
- Huge Storage Space
- The baskets is easy to move and clean
- All items are easy to easily accessible

Available Size

Carcass size (outer to outer)	Product Specification (mm)	Article No.	Price
450 mm	405 x 500 x (1780 Above)	HKCPP.07.450(6)	₹ 41327/-
600 mm	555 x 500 x (1780 Above)	HKCPP.07.600(6)	₹ 49049/-

2-Tier Charcoal Bottle Pull Out



Product Advantages

- Easy to install
- Add environmental anti-slip mat
- 4 Baskets, Bearing 30 kg.
- Huge Storage Space
- All items are easy to reach
- 200mm, 250mm size is Side mounted (Soft close).

Available Size

Carcass size (outer to outer)	Product Specification (mm)	Article No.	Price
200 mm	155 x 500 x 490	HKCBP.04.200	₹ 10080/-
250 mm	200 x 500 x 490	HKCBP.04.250	₹ 11005/-

S-Carousel Soft-Close (Left & Right)

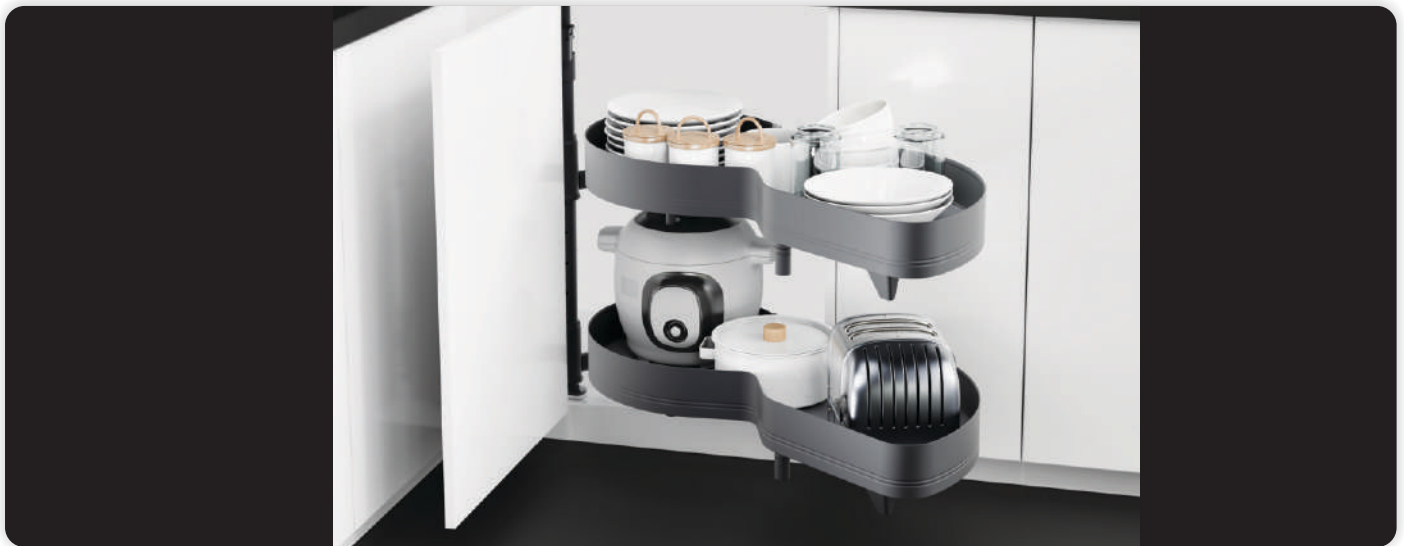

Frame is made of High -Quality steel, surface treatment process for European standard environmental spraying is adopted. Passed through European environmental standard Cr. electro plating to ensure it can stand wear an tear. The Central Pole works smoothly.

Product Advantages

- Easy to install and adjust the height of tray
- Add environmental anti-slip mat
- Improve the space utilization
- Single tray can bear 25kg.

Available Size

Carcass size (outer to outer)	Product Specification (mm)	Article No.	Price
1050-1100 mm	495x865x(600-750)	HKCC.29.600(L)	₹ 21582/-
1050-1100 mm	495x865x(600-750)	HKCC.29.600(R)	₹ 21582/-

Universal Magic Corner - Charcoal (Soft-Close)



Available Size

Carcass size (outer to outer)	Product Specification (mm)	Door width (mm)	Article No.	Price
800-900 mm	650 x 455 x 590	≥ 400	HKC.29.600(U)	₹ 39000/-

Installation Video Link:

<https://youtu.be/-fhPupMwF4g>

Hardwyn
Since 1965
Perfection Redefined





Lenia Wire Series

Lenia Basket is Made of High-Quality Stainless Steel and features a Permanent Handle for Easy Installation.

In-House Manufactured by Skilled Experts.

Adds Comfort And Style to Your Kitchen.

Plain Basket



Available Size

Carcass size (outer to outer)	Product Specification (mm)	Article No.	Price
450 mm	375 x 500 x 100	HKLWPL.41.375.100	₹ 1925/-
450 mm	375 x 500 x 150	HKLWPL.41.375.150	₹ 2455/-
450 mm	375 x 500 x 200	HKLWPL.41.375.200	₹ 2785/-
500 mm	425 x 500 x 100	HKLWPL.41.425.100	₹ 2435/-
500 mm	425 x 500 x 150	HKLWPL.41.425.150	₹ 2925/-
500 mm	425 x 500 x 200	HKLWPL.41.425.200	₹ 3105/-
550 mm	475 x 500 x 100	HKLWPL.41.475.100	₹ 2785/-
550 mm	475 x 500 x 150	HKLWPL.41.475.150	₹ 3380/-
550 mm	475 x 500 x 200	HKLWPL.41.475.200	₹ 3575/-
600 mm	530 x 500 x 100	HKLWPL.41.530.100	₹ 2915/-
600 mm	530 x 500 x 150	HKLWPL.41.530.150	₹ 3520/-
600 mm	530 x 500 x 200	HKLWPL.41.530.200	₹ 3720/-

Perforated Cutlery Basket



Available Size

Carcass size (outer to outer)	Product Specification (mm)	Article No.	Price
450 mm	375 x 500 x 100	HKLWCT.42.375.100	₹ 4050/-
500 mm	425 x 500 x 100	HKLWCT.42.425.100	₹ 4785/-
550 mm	475 x 500 x 100	HKLWCT.42.475.100	₹ 5345/-
600 mm	530 x 500 x 100	HKLWCT.42.530.100	₹ 5830/-

Cup & Saucer Partition

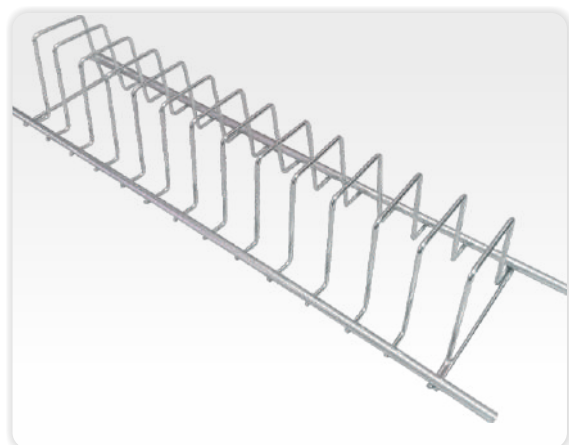

Article No.	Price
HKLWCS.PTP	₹ 880/-

Plate Partition

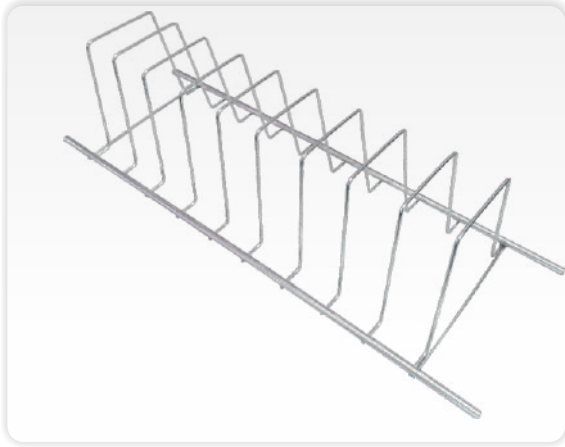

Article No.	Price
HKLWPT.PTP	₹ 1135/-

Thali Partition

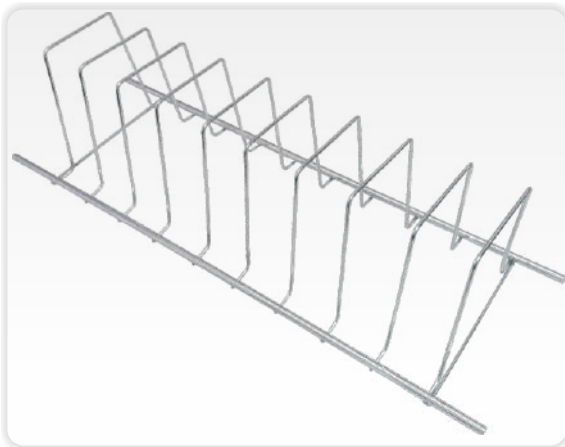

Article No.	Price
HKLWTH.PTP	₹ 1400/-

Grain Trolley



Available Size

Carcass size (outer to outer)	Product Specification (mm)	Article No.	Price
450 mm	375 x 500 x 304	HKLWGT.49.375.304	₹ 5845/-
500 mm	425 x 500 x 304	HKLWGT.49.425.304	₹ 6540/-
550 mm	475 x 500 x 304	HKLWGT.49.475.304	₹ 7340/-
600 mm	530 x 500 x 304	HKLWGT.49.530.304	₹ 8005/-

2-Tier Bottle Pullout



Available Size

Carcass size (outer to outer)	Product Specification (mm)	Article No.	Price
150 mm	100 x 500 x 450	HKLW2T.50.100	₹ 4620/-
200 mm	150 x 500 x 450	HKLW2T.50.150	₹ 5260/-
250 mm	200 x 500 x 450	HKLW2T.50.200	₹ 5945/-

3-Tier Bottle Pullout



Available Size

Carcass size (outer to outer)	Product Specification (mm)	Article No.	Price
150 mm	100 x 500 x 530	HKLW3T.51.100	₹ 5980/-
200 mm	150 x 500 x 530	HKLW3T.51.150	₹ 6940/-
250 mm	200 x 500 x 530	HKLW3T.51.200	₹ 7435/-

Detergent Rack



Available Size

Carcass size (outer to outer)	Product Specification (mm)	Article No.	Price
.....	160 x 305 x 365	HKLWDR.53.100	₹ 1320/-

Pantry Pull-Out



Available Size

Carcass size (outer to outer)	Product Specification (mm)	Article No.	Price
450 mm	385 x 500 x (1825-2125)	HKLWPP.55.450(6L)	₹ 27060/-
600 mm	485 x 500 x (1825-2125)	HKLWPP.55.600(6L)	₹ 35080/-
450 mm	385 x 500 x (1100-1400)	HKLWPP.55.450(4L)	₹ 24375/-
600 mm	485 x 500 x (1100-1400)	HKLWPP.55.600(4L)	₹ 31680/-

Tall Unit



Available Size

Carcass size (outer to outer)	Product Specification (mm)	Article No.	Price
450 mm	374 x 500 x (1825-2125)	HKLWTUS.56.6L	₹ 29725/-

Magic Corner Organizer (Universal)



Available Size

Carcass size (outer to outer)	Product Specification (mm)	Article No.	Price
1050-1100 mm	450 x 570 x 1050	HKLWMCO.57	₹ 18865/-

Cylinder Trolley



Available Size

Carcass size (outer to outer)	Product Specification (mm)	Article No.	Price
.....	Dia 290mm	HKLWCT.62	₹ 1110/-

Use-me Shutter



Available Size

Carcass size (outer to outer)	Product Specification (mm)	Article No.	Price
.....	300 x 200 x 300	HKLWUS.63	₹ 1190/-

Bin Holder



Available Size

Carcass size (outer to outer)	Product Specification (mm)	Article No.	Price
.....	Dia 250	HKLWBH.64	₹ 1140/-

3/4 - Carousel 270°



Available Size

Carcass size (outer to outer)	Article No.	Price
450x450 mm	HKLWC.18.270	₹ 7515/-
525x525 mm	HKLWC.21.270	₹ 9050/-
600x600 mm	HKLWC.24.270	₹ 10650/-
675x675 mm	HKLWC.27.270	₹ 12180/-
750x750 mm	HKLWC.30.270	₹ 13780/-
800x800 mm	HKLWC.32.270	₹ 15315/-

PARTITIONS

For
Motion Drives & Duro Box

THALI PARTITION

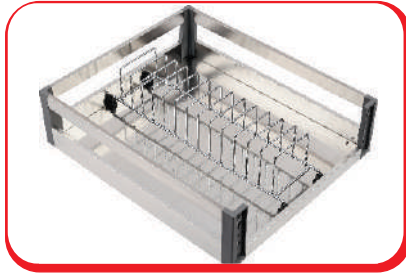

Product	Per	Depth	Article No.	Price
Thali Partition	Pc	500 mm	HKPTP.13.500	₹ 1380/-

PLATE PARTITION

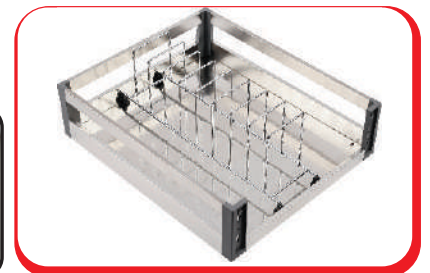

Product	Per	Depth	Article No.	Price
Plate Partition	Pc	500 mm	HKPPP.13.500	₹ 1380/-

QUARTER PLATE HOLDER

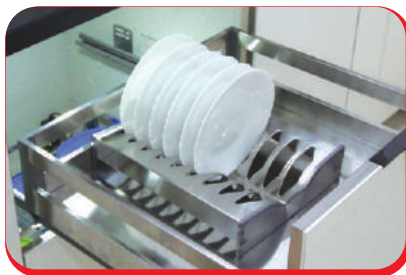

Product	Per	Depth	Article No.	Price
Quarter P. Holder	Pc	500 mm	HKPQP.13.500	₹ 2240/-

CUP & SAUCER PARTITION

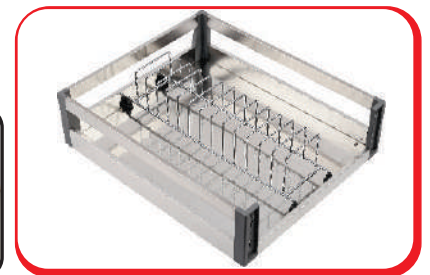

Product	Per	Depth	Article No.	Price
Cup & Saucer Holder	Pc	500 mm	HKPCS.13.500	₹ 1380/-

BOWL HOLDER

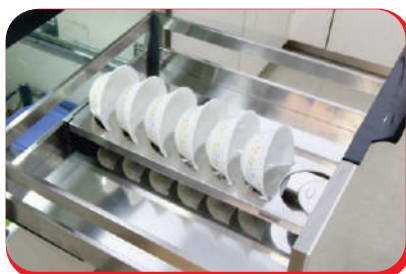

Product	Per	Depth	Article No.	Price
Bowl Holder	Pc	500 mm	HKPBH.13.500	₹ 1750/-

CUTLERY PARTITIONS



Item No.	Specification (WxDxH) mm	Cabinet Size	Price
HKCP-01	280x472x64	500 mm	₹ 4660/-

Item No.	Specification (WxDxH) mm	Cabinet Size (mm)	Price
HKCP-02	290x472x64	500	₹ 3645/-



Item No.	Specification (WxDxH) mm	Cabinet Size	Price
HKCP-03	103x472x64	500 mm	₹ 2540/-



*Image for reference only.



Hardwyn
Since 1965
Perfection Redefined

**A KITCHEN IS INCOMPLETE
WITHOUT CORNERS ■ ■**

3/4 - Carousel 270°



Product Advantages

- Easy to install and adjust the height of tray
- Add environmental anti-slip mat
- Improve the space utilization
- Single tray can bear 25kg.

Frame is made of High -Quality steel, surface treatment process for European standard environmental spraying is adopted. Passed through European environmental standard Cr. electro plating to ensure it can stand wear an tear. The Central Pole works smoothly.

Available Size

Carcass size (outer to outer)	Product Specification (mm)	Article No.	Price
900 x 900	Ø710 x H-(565-790)	HKC.21.270	₹ 17010/-

S-Carousel Soft-Close (Left & Right)



Product Advantages

- Easy to install and adjust the height of tray
- Add environmental anti-slip mat
- Improve the space utilization
- Single tray can bear 25kg.

Frame is made of High -Quality steel, surface treatment process for European standard environmental spraying is adopted. Passed through European environmental standard Cr. electro plating to ensure it can stand wear an tear. The Central Pole works smoothly.

S-Carousel W/O Soft-Close (Left & Right)

Available Size

Carcass size (outer to outer)	Product Specification (mm)	Article No.	Price
1050-1100 mm	495x865x(600-750)	HKSC.29.600(L)	₹ 17985/-
1050-1100 mm	495x865x(600-750)	HKSC.29.600(R)	₹ 17985/-

Available Size

Carcass size (outer to outer)	Product Specification (mm)	Article No.	Price
1050-1100 mm	495x865x(600-750)	HKWSC.29.600(L)	₹ 15120/-
1050-1100 mm	495x865x(600-750)	HKWSC.29.600(R)	₹ 15120/-

Casario System



Product Advantages

- 2 Small And 2 Big Storage Container
- Cabinet with optional width from 600 mm
- Minimum depth of wall unit: 290 mm
- Height of side when closed: 140 mm

Available Size

Carcass size (outer to outer)	Product Specification (mm)	Article No.	Price
600 mm	W-557 x D-325 x H-165	HKC.33	₹ 37815/-

Dish Rack with Drip Tray



Product Advantages

- High Quality Materials, Functional. Easy installation, beautiful appearance
- 8 to 30 cm in diameter of the plate can be put on, to make sure that the solid plate
- Dish rack is of high quality Stainless steel plate and new ABS plastic.
- Cabinet with optional width from 600 mm to 900 mm.

Available Size

Carcass size (outer to outer)	Product Specification (mm)	Article No.	Price
600 mm	564 x 280 x 95	HKPDR.34.600	₹ 1950/-
700 mm	664 x 280 x 95	HKPDR.34.700	₹ 2280/-
800 mm	764 x 280 x 95	HKPDR.34.800	₹ 2580/-
900 mm	864 x 280 x 95	HKPDR.34.900	₹ 2880/-

Waste Bin S.S.



Available Size

Size(Litre)	Product Specification (mm)	Article No.	Price
9 L	W-255 x D-310 x H-330	HKAD.35.9L	₹ 2640/-
14 L	W-275 x D-335 x H-350	HKAD.35.14L	₹ 3490/-

Waste Bin PVC



Available Size

Size(Litre)	Product Specification (mm)	Article No.	Price
20L x 2	W-340 x D-490 x H-430	HKADD.36.20L	₹ 10505/-

Elevator System



Product Advantages

- Panel with embossed processing
- Pull the basket smooth mute
- Stainless steel surface using the latest nano hydrophobic oil processing technology, the oil are difficult to stick
- Lift force is adjustable

Available Size

Carcass size (outer to outer)	Product Specification (mm)	Article No.	Price
600	W-564 x D-280 x H-650	HKE.37.600	₹ 33840/-
900	W-864 x D-280 x H-650	HKE.37.900	₹ 35110/-

Gear	Condition of Gear	Load bearing
Neutral gear	Both buttons remain unpressed	0-4 KG
First gear	Left button is pressed while right button remain unpressed	3-6KG
Second gear	Left button remain unpressed while right button is pressed	5-8 KG
Third gear	Both buttons are pressed	7-10KG

Notes: Make sure the basket is in initial position (stayed in cabinet) when shifting gears.

Rolling Shutter Door (Aluminum)



Available Size

Carcass size (outer to outer)	Product Specification (mm)	Article No.	Price
450 mm	W-450 x H-1320	HKRS.31.450(alu.)	₹ 25950/-
600 mm	W-600 x H-1320	HKRS.31.600(alu.)	₹ 27340/-

Rolling Shutter Door (PVC) (Silver/Black)



Available Size

Carcass size (outer to outer)	Product Specification (mm)	Article No.	Price
450 mm	W-450 x H-1320	HKRS.31.450(PVC)	₹ 21340/-
600 mm	W-600 x H-1320	HKRS.31.600(PVC)	₹ 22340/-

Rolling Shutter Door (Glass white)



Available Size

Carcass size (outer to outer)	Product Specification (mm)	Article No.	Price
600 mm	W-600 x H-1320	HKRSG.31.600(W)	₹ 44000/-

Rolling Shutter Door (Glass Black)



Available Size

Carcass size (outer to outer)	Product Specification (mm)	Article No.	Price
600 mm	W-600 x H-1320	HKRSG.31.600(B)	₹ 44000/-

- Save Space in Kitchen
- Antirust and fashionable
- Easy Installation, maintenance and cleaning



Multifunctional Knife Rack



Specification	Article No.	Price
350x115x200	HKHA.001	₹ 3948/-

2-Tier Condiment Rack



Specification	Article No.	Price
350x115x300	HKHA.002	₹ 5080/-

Condiment Rack with Fence



Specification	Article No.	Price
350x115x200	HKHA.003	₹ 3630/-

Condiment Rack



Specification	Article No.	Price
350x115x200	HKHA.004	₹ 3420/-

Square Barrel Rack



Specification	Article No.	Price
116x115x200	HKHA.005	₹ 2365/-

Hanging Rod



Specification	Article No.	Price
900x16x40	HKHA.006	₹ 1915/-

Wooden Cutlery



Available Size

Color	Article No.	Price
Wooden	HKWC.600	₹ 9135/-
Wooden	HKWC.900	₹ 11445/-

Slim Box (45 Kg)



Available Size

Size(mm)	Color	Article No.	Price
500x100	Grey	HWSBG.500.100	₹ 4100/-
500x150	Grey	HWSBG.500.150	₹ 4500/-
500x200	Grey	HWSBG.500.200	₹ 4800/-
500x250	Grey	HWSBG.500.250	₹ 5100/-

*Available in Grey colour only.

Available Size

Size(mm)	Color	Article No.	Price
400x100	Grey	HWSBG.400.100	₹ 3900/-
400x150	Grey	HWSBG.400.150	₹ 4300/-
400x200	Grey	HWSBG.400.200	₹ 4600/-

*Available in Grey colour only.

Size(mm)	Color	Article No.	Price
450x100	Grey	HWSBG.450.100	₹ 4000/-
450x150	Grey	HWSBG.450.150	₹ 4400/-
450x200	Grey	HWSBG.450.200	₹ 4700/-

*Available in Grey colour only.

Size(mm)	Color	Article No.	Price
550x100	Grey	HWSBG.550.100	₹ 4300/-
550x150	Grey	HWSBG.550.150	₹ 4700/-
550x200	Grey	HWSBG.550.200	₹ 5000/-
550x250	Grey	HWSBG.550.250	₹ 5300/-

*Available in Grey colour only.

Size(mm)	Color	Article No.	Price
600x100	Grey	HWSBG.600.100	₹ 4500/-
600x150	Grey	HWSBG.600.150	₹ 4900/-
600x200	Grey	HWSBG.600.200	₹ 5200/-

*Available in Grey colour only.

Note: Total Height (100mm, 150mm, 200mm & 250mm) is INCLUSIVE of Quadro

Duro Box (INOTECH)



Available Size

Size(mm)	Color	Article No.	Price
400	Grey	HKDBG.400	₹ 3000/-
450	Grey	HKDBG.450	₹ 3200/-
500	Grey	HKDBG.500	₹ 3400/-
550	Grey	HKDBG.550	₹ 3600/-

*Available in Grey colour only.

Single Gallery For Duro Box (Square)



Available Size

Size(mm)	Color	Article No.	Price
400	Grey	HKDBG.400 (2S)	₹ 620/-
450	Grey	HKDBG.450 (2S)	₹ 645/-
500	Grey	HKDBG.500 (2S)	₹ 665/-
550	Grey	HKDBG.550 (2S)	₹ 780/-

Double Gallery For Duro Box (Square)



Available Size

Size(mm)	Color	Article No.	Price
400	Grey	HKDBG.400 (4S)	₹ 840/-
450	Grey	HKDBG.450 (4S)	₹ 870/-
500	Grey	HKDBG.500 (4S)	₹ 955/-
550	Grey	HKDBG.550 (4S)	₹ 1000/-

● Weight Capacity- 45 kg.

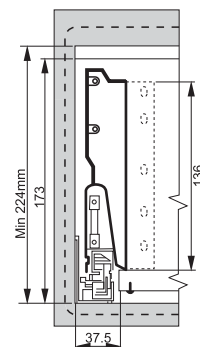
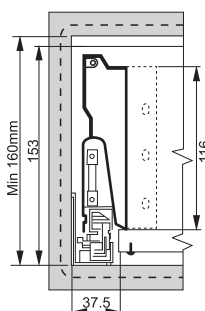
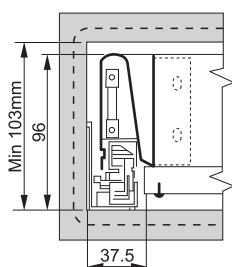



Bi Fold Up Lifter



- Material: Zinc alloy+Plastic+Iron
- Finish: Nickel Plating, Chrome Plating
- Capacity Range: different options
- Use for high wall cabinet with 2 door panels
- Shutter Height: 600mm - 720mm
- Shutter Width: 600mm - 900mm

Article No.	Load capacity	Price
HKL0.008	7-8 Kg	₹ 8800/-
	9-10 Kg	₹ 9000/-
	10-14 Kg	₹ 11500/-

Gas Pump with soft Close Mechanism



Gas up lifter closes softly when the cabinet is closed. This Fitting can be installed on the wooden or aluminum frame

- Gas up lifter available with 5, 10, 15, 20, 25kg. weight Capacity
- Gas Pump with soft close Mechanism

Article No.	Price PerPc
HKL0.006	₹ 315/-

Single Up Lifter (Aventos) Mechanism



- Shutter Width : 600-900mm
- Load Capacity : 5 - 10kg

Article No.	Price
HKL0.009	₹ 4500/-



Concealed Hinges (Regular without Soft Close)



Article No.	Price Per Set
HCH-0°	₹ 100/-
HCH-8°	
HCH-15°	

Concealed Hinges 3D (with Soft Close)



Article No.	Price Per Set
HHCHR-0°	₹ 375/-
HHCHR-8°	
HHCHR-15°	

Open Angle 110°
Diameter of hinge cup Ø35mm Cup
hole Distance 45mm, 48mm, 52mm
Range of door thickness 14-24mm
Depth of hinge cup 11.3mm

Concealed Hinges 2D (with Soft Close)



Article No.	Price Per Set
HHCH-0°	₹ 275/-
HHCH-8°	
HHCH-15°	

Open Angle 110°
Diameter of hinge cup Ø35mm Cup
hole Distance 45mm, 48mm, 52mm
Range of door thickness 14-24mm
Depth of hinge cup 11.3mm

Concealed Hinges 3D Black (with Soft Close)



Article No.	Price Per Set
HHCHR-BK-0°	₹ 425/-
HHCHR-BK-8°	
HHCHR-BK-15°	

Open Angle 110°
Diameter of hinge cup Ø35mm Cup
hole Distance 45mm, 48mm, 52mm
Range of door thickness 14-24mm
Depth of hinge cup 11.3mm

Slip On Hinges



Article No.	Price Per Set
HSH-0°	₹ 240/-
HSH-8°	
HSH-15°	

Open Angle 110°
Diameter of hinge cup Ø35mm Cup
hole Distance 45mm, 48mm, 52mm
Range of door thickness 14-24mm
Depth of hinge cup 11.3mm

Concealed Hinges 3D S.S. (with Soft Close)



Material : Stainless Steel

Article No.	Price Per Set
HHCHR-SS-0°	₹ 500/-
HHCHR-SS-8°	
HHCHR-SS-15°	

Open Angle 110°
Diameter of hinge cup Ø35mm Cup
hole Distance 45mm, 48mm, 52mm
Range of door thickness 14-24mm
Depth of hinge cup 11.3mm

Concealed Hinges Pie (without Soft Close)



Article No.	Price Per Set
HCH-95°	₹ 330/-

Hinges Cap Type

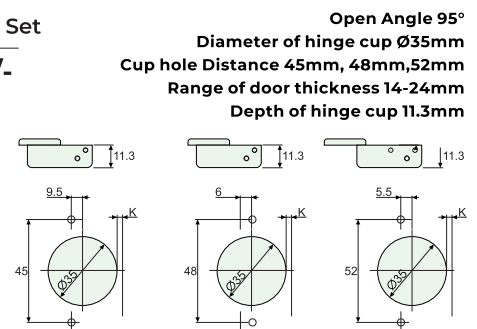

Concealed Hinges Corner (With Soft Close)



Article No.	Price Per Set
HCH-165°	₹ 1000/-

D	K	3	4	5	6	7	8
0		19	20	21	22	23	24
2		17	18	19	20	21	22
4		15	16	17	18	19	20

Open Angle 165°
Diameter of hinge cup Ø35mm
Cup hole Distance 45mm, 48mm, 52mm
Range of door thickness 14-24mm
Depth of hinge cup 11.3mm

Hinges Cap Type

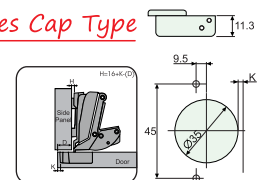

Hydraw Wooden Slides



Available Size

Size(in.)	Size (mm)	Article No.	Price
12	300	HKHD.300	₹ 1780/-
14	350	HKHD.350	₹ 1880/-
16	400	HKHD.400	₹ 1980/-
18	450	HKHD.450	₹ 2150/-
20	500	HKHD.500	₹ 2250/-
22	550	HKHD.550	₹ 2475/-

- Material : Galvanized steel
- Load capacity : 40-45kg.
- Features:
 1. Tool-free quick installation
 2. Quiet system guarantees the slides run Smoothly without noise
 3. Drawer height adjustable for 0-2mm
 4. Self and soft-closing functions make the drawer close safely without effect of weight

Telescopic Channel - Push to Open



Available Size

Size(in.)	Size (mm)	Article No.	Price
20	500	HEP-TELE.020	₹ 1050/-

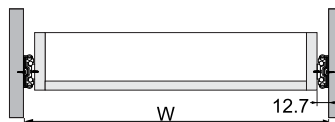

Same Dimension apply in all Channel

- Side Width : 45mm
- Material : Work hardened cold rolled steel.
- Mounting : Side for frame and frameless construction
- Load capacity : 45kg.
- Finish : Zinc

Telescopic Channel - Soft Close



Available Size

Size(in.)	Size (mm)	Article No.	Price
12	300	HEPSC-TELE.012	₹ 650/-
14	350	HEPSC-TELE.014	₹ 775/-
16	400	HEPSC-TELE.016	₹ 875/-
18	450	HEPSC-TELE.018	₹ 1000/-
20	500	HEPSC-TELE.020	₹ 1100/-
22	550	HEPSC-TELE.022	₹ 1200/-
24	600	HEPSC-TELE.024	₹ 1300/-

- Side Width : 45mm
- Material : Work hardened cold rolled steel.
- Mounting : Side for frame and frameless construction
- Load capacity : 45kg.
- Finish : Zinc

Telescopic Channel - Black (Economy)



Available Size

Size(in.)	Size (mm)	Article No.	Price
10	250	HEPB-E-TELE.010	₹ 260/-
12	300	HEPB-E-TELE.012	₹ 310/-
14	350	HEPB-E-TELE.014	₹ 375/-
16	400	HEPB-E-TELE.016	₹ 425/-
18	450	HEPB-E-TELE.018	₹ 500/-
20	500	HEPB-E-TELE.020	₹ 550/-
22	550	HEPB-E-TELE.022	₹ 600/-
24	600	HEPB-E-TELE.024	₹ 650/-

- Side Width : 45mm
- Material : Work hardened cold rolled steel.
- Mounting : Side for frame and frame less construction
- Load capacity : 35-40kg. Finish : Black

Telescopic Channel - Zinc (Economy)



Available Size

Size(in.)	Size (mm)	Article No.	Price
10	250	HEPZ-E-TELE.010	₹ 260/-
12	300	HEPZ-E-TELE.012	₹ 310/-
14	350	HEPZ-E-TELE.014	₹ 375/-
16	400	HEPZ-E-TELE.016	₹ 425/-
18	450	HEPZ-E-TELE.018	₹ 500/-
20	500	HEPZ-E-TELE.020	₹ 550/-
22	550	HEPZ-E-TELE.022	₹ 600/-
24	600	HEPZ-E-TELE.024	₹ 650/-

- Side Width : 45mm
- Material : Work hardened cold rolled steel.
- Mounting : Side for frame and frame less construction
- Load capacity : 35-40kg. Finish : Zinc

Telescopic Channel - Black (Premium)



Available Size

Size(in.)	Size (mm)	Article No.	Price
10	250	HEPB-TELE.010	₹ 300/-
12	300	HEPB-TELE.012	₹ 350/-
14	350	HEPB-TELE.014	₹ 425/-
16	400	HEPB-TELE.016	₹ 475/-
18	450	HEPB-TELE.018	₹ 550/-
20	500	HEPB-TELE.020	₹ 600/-
22	550	HEPB-TELE.022	₹ 650/-
24	600	HEPB-TELE.024	₹ 725/-
26	650	HEPB-TELE.026	₹ 775/-
30	750	HEPB-TELE.030	₹ 900/-
36	900	HEPB-TELE.036	₹ 1075/-

- Side Width : 45mm
- Material : Work hardened cold rolled steel.
- Mounting : Side for frame and frame less construction
- Load capacity : 45-50kg. Finish : Black

Telescopic Channel - Zinc (Premium)



Available Size

Size(in.)	Size (mm)	Article No.	Price
10	250	HEPZ-TELE.010	₹ 300/-
12	300	HEPZ-TELE.012	₹ 350/-
14	350	HEPZ-TELE.014	₹ 425/-
16	400	HEPZ-TELE.016	₹ 475/-
18	450	HEPZ-TELE.018	₹ 550/-
20	500	HEPZ-TELE.020	₹ 600/-
22	550	HEPZ-TELE.022	₹ 650/-
24	600	HEPZ-TELE.024	₹ 725/-
26	650	HEPZ-TELE.026	₹ 775/-
30	750	HEPZ-TELE.030	₹ 900/-
36	900	HEPZ-TELE.036	₹ 1075/-

- Side Width : 45mm
- Material : Work hardened cold rolled steel.
- Mounting : Side for frame and frame less construction
- Load capacity : 45-50kg. Finish : Zinc

PROFILES ALUMINIUM







Matt Black





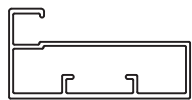

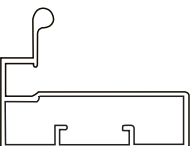
Gold

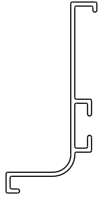
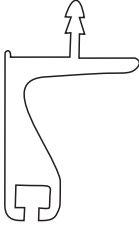

Rose Gold

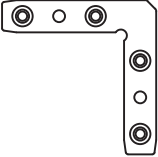
Application	Image	Type	Finish	Item Code	MRP
Profile for Glass Shutter		45mm Frame Profile	Black Matt Rose Gold Gold	HEAP-45F 3M BM HEAP-45F 3M Rose Gold HEAP-45F 3M Gold	₹ 2600/-
		68mm Alu Handle Frame Profile	Black Matt Rose Gold Gold	HEAP-45H 3M BM HEAP-45H 3M Rose Gold HEAP-45H 3M Gold	₹ 3100/-
		45mm Handle	Black Matt Rose Gold Gold	HEAP-45-I 3M BM HEAP-45-I 3M Rose Gold HEAP-45-I 3M Gold	₹ 3000/-
Profile for Wooden Shutter		J Profile	Black Matt Rose Gold Gold	HEAP-J 3M BM HEAP-J 3M Rose Gold HEAP-J 3M Gold	₹ 2200/-
		G Profile	Black Matt Rose Gold Gold	HEAP-G 3M BM HEAP-G 3M Rose Gold HEAP-G 3M Gold	₹ 2400/-

Application	Image	Type	Finish	Item Code	MRP
Gola Profile		C - Gola Profile	Black Matt Rose Gold Gold	HEAP-CG 3M BM HEAP-CG 3M Rose Gold HEAP-CG 3M Gold	₹ 2300/-
		J - Gola Profile	Black Matt Rose Gold Gold	HEAP-JG 3M BM HEAP-JG 3M Rose Gold HEAP-JG 3M Gold	₹ 1800/-
		A Profile	Black Matt Rose Gold Gold	HEAP-A 3M BM HEAP-A 3M Rose Gold HEAP-A 3M Gold	₹ 2000/-
		F Profile	Black Matt Rose Gold Gold	HEAP-F 3M BM HEAP-F 3M Rose Gold HEAP-F 3M Gold	₹ 1900/-
Connector		90 Connector for 45mm Glass Profile	Finish : Zinc	HEAP-ACC-1 STD	₹ 300/- (Set of 4 Pcs.)
End Cap		End Cap For G Profile	Black Matt Rose Gold Gold	HEAP-EC-BM HEAP-EC-Rose Gold HEAP-EC-Gold	₹ 90/- (Set of 2 Pcs.)



WARDROBE WHITE ACCESSORIES ■ ■



Hanger Drop Down



Heavy Duty With Weight

Capacity 30 Kg.

Both Way Soft Close.

Available Size

Wardrobe Inside Width	Specification (mm)	Article No.	Price
764-1064	(764-1064)x140x900	HW(W).101	₹ 6100/-

Soft-Closing Cane Basket



Available Size

Wardrobe Inside Width	Specification (mm)	Article No.	Price
559-649	559 x 460 x 200	HW(W).102.600	₹ 13780/-
859-949	859 x 460 x 200	HW(W).102.900	₹ 16025/-

LED Hanger Rod



Available Size

Wardrobe Inside Width	Specification (mm)	Article No.	Price
564	HW(W).103.600	₹ 4915/-
864	HW(W).103.900	₹ 5660/-

Soft-Closing Trouser Rack



Available Size

Wardrobe Inside Width	Specification (mm)	Article No.	Price
559-649	559 x 460 x 60	HW(W).104.600	₹ 9570/-
859-949	859 x 460 x 60	HW(W).104.900	₹ 11865/-

Soft-Closing Decorative Shelf



Available Size

Wardrobe Inside Width	Specification (mm)	Article No.	Price
559-589	559 x 460 x 80	HW(W).105.600	₹ 15310/-
859-889	859 x 460 x 80	HW(W).105.900	₹ 18755/-

Soft-Closing Top Trouser Rack



Available Size

Wardrobe Inside Width	Specification (mm)	Article No.	Price
.....	650 x 460 x 135	HW(W).107	₹ 9185/-

Soft-Closing Storage Glass Basket



Available Size

Wardrobe Inside Width	Specification (mm)	Article No.	Price
559-649	559 x 460 x 170	HW(W).113.600	₹ 13780/-
859-949	859 x 460 x 170	HW(W).113.900	₹ 16075/-

without Soft-Closing Multi Functional Tie Rack



Available Size - Universal

Wardrobe Inside Width	Specification (mm)	Article No.	Price
.....	140 x 460 x 70	HW(W).110	₹ 2240/-

Soft-Closing Shoe Rack



Available Size

Wardrobe Inside Width	Specification (mm)	Article No.	Price
559-649	559 x 460 x 170	HW(W).114.600	₹ 11480/-
859-949	859 x 460 x 170	HW(W).114.900	₹ 13780/-

Multi-Functional Swinga Mirror



- The Whole structure is made of high-Quality aluminium alloy. Slide still can be Used smoothly for its long service.
- Perfect assembly, stable structure and easy to install. Environmental paint silvery white decorations make the wardrobe luxury and fashion.

Available Size

Wardrobe Inside Width	Specification (mm)	Article No.	Price
350	290 x 460 x 1200	HW(W).111	₹ 8270/-



WARDROBE MOCHA ACCESSORIES

Soft-Closing Shoe Rack 360°



Material: Alu. alloy + ABS + IronLeather
Color: **MOCHA**

Available Size

Layers	Specification (mm)	Article No.	Price
12 layers	700×360×1910-2110	HW(M).115	₹ 52000/-

Hanger Drop Down



Material: Iron+ABS
 Color: **MOCHA**

Available Size

Cabinet Size (mm)	Specification (mm)	Article No.	Price
960mm	920-1240x140x820	HW(M).101	₹ 6500/-

Soft-Closing Cane Basket



Material: Alu. alloy + ABS + Iron
 Color: **MOCHA**

Available Size

Cabinet Size (mm)	Specification (mm)	Article No.	Price
600	564x460x165	HW(M).102.600	₹ 14600/-
900	864x460x165	HW(M).102.900	₹ 17050/-

Soft-Closing Trouser Rack



Material: Alu. alloy + ABS + Iron
 Color: **MOCHA**

Available Size

Cabinet Size (mm)	Specification (mm)	Article No.	Price
600	564x460x71	HW(M).104.600	₹ 10150/-
900	864x460x71	HW(M).104.900	₹ 12580/-

Soft-Closing Decorative Shelf



Material: Alu. alloy + ABS + Iron
 Color: **MOCHA**

Available Size

Cabinet Size (mm)	Specification (mm)	Article No.	Price
600	564x460x71	HW(M).105.600	₹ 16230/-
900	864x460x71	HW(M).105.900	₹ 19880/-

Soft-Closing Top Trouser Rack



Material: Alu. alloy+Iron+Non-slip flocking tube
 Color: **MOCHA**

Available Size

Cabinet Size (mm)	Specification (mm)	Article No.	Price
700	630x455x115	HW(M).107	₹ 9750/-

without Soft-Closing Multi Functional Tie Rack



Material: Alu. alloy+ABS+Steel
 Color: **MOCHA**

Available Size

Cabinet Size (mm)	Specification (mm)	Article No.	Price
.....	100x430x80	HW(M).110	₹ 2375/-

Soft-Closing Storage Glass Basket



Material: Alu. alloy+ABS+Glass+Iron
Color: **MOCHA**

Available Size

Cabinet Size (mm)	Specification (mm)	Article No.	Price
600	564x460x165	HW(M).113.600	₹ 14600/-
900	864x460x165	HW(M).113.900	₹ 17050/-

Soft-Closing Shoe Rack



Material: Alu. alloy + ABS + Iron
Color: **MOCHA**

Available Size

Cabinet Size (mm)	Specification (mm)	Article No.	Price
600	564x460x170	HW(M).114.600	₹ 12170/-
900	864x460x170	HW(M).114.900	₹ 14600/-

Multi-Functional Swinga Mirror

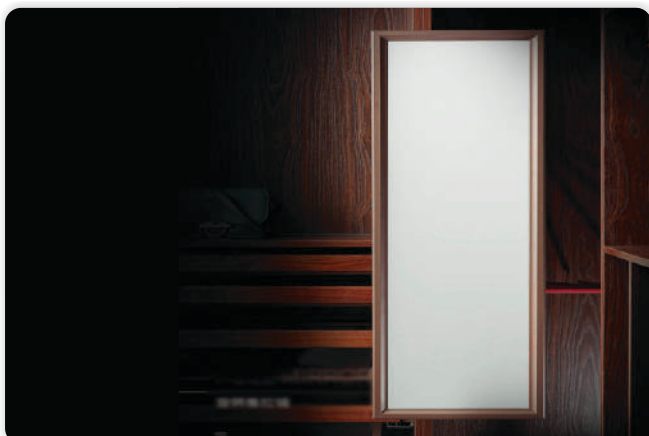

Material: Alu. alloy+ABS+Steel
Color: **MOCHA**

Available Size

Cabinet Size (mm)	Specification (mm)	Article No.	Price
350	1200x350	HW(M).111	₹ 8770/-



WARDROBE GREY ACCESSORIES

Soft-Closing Shoe Rack 360°



Material: Alu. alloy + ABS + Iron Leather
Color: GREY

Available Size

Layers	Specification (mm)	Article No.	Price
12 layers	700×360×1910-2110	HW(G).115	₹ 52000/-

Hanger Drop Down



Material: Iron+ABS
 Color: **GREY**

Available Size

Cabinet Size (mm)	Specification (mm)	Article No.	Price
960mm	920-1240x140x820	HW(G).101	₹ 6500/-

Soft-Closing Cane Basket



Material: Alu. alloy + ABS + Iron
 Color: **GREY**

Available Size

Cabinet Size (mm)	Specification (mm)	Article No.	Price
600	564x460x165	HW(G).102.600	₹ 14600/-
900	864x460x165	HW(G).102.900	₹ 17050/-

Soft-Closing Trouser Rack



Material: Alu. alloy + ABS + Iron
 Color: **GREY**

Available Size

Cabinet Size (mm)	Specification (mm)	Article No.	Price
600	564x460x71	HW(G).104.600	₹ 10150/-
900	864x460x71	HW(G).104.900	₹ 12580/-

Soft-Closing Decorative Shelf



Material: Alu. alloy + ABS + Iron
 Color: **GREY**

Available Size

Cabinet Size (mm)	Specification (mm)	Article No.	Price
600	564x460x71	HW(G).105.600	₹ 16230/-
900	864x460x71	HW(G).105.900	₹ 19880/-

Soft-Closing Top Trouser Rack



Material: Alu. alloy+Iron+Non-slip flocking tube
 Color: **GREY**

Available Size

Cabinet Size (mm)	Specification (mm)	Article No.	Price
700	630x455x115	HW(G).107	₹ 9750/-

without Soft-Closing Multi Functional Tie Rack



Material: Alu. alloy+ABS+Steel
 Color: **GREY**

Available Size

Cabinet Size (mm)	Specification (mm)	Article No.	Price
.....	100x430x80	HW(G).110	₹ 2375/-

Soft-Closing Storage Glass Basket



Material: Alu. alloy+ABS+Glass+Iron
 Color: **GREY**

Available Size

Cabinet Size (mm)	Specification (mm)	Article No.	Price
600	564x460x165	HW(G).113.600	₹ 14600/-
900	864x460x165	HW(G).113.900	₹ 17050/-

Soft-Closing Shoe Rack



Material: Alu. alloy + ABS + Iron
 Color: **GREY**

Available Size

Cabinet Size (mm)	Specification (mm)	Article No.	Price
600	564x460x170	HW(G).114.600	₹ 12170/-
900	864x460x170	HW(G).114.900	₹ 14600/-

Multi-Functional Swinga Mirror



Material: Alu. alloy+ABS+Steel
 Color: **GREY**

Available Size

Cabinet Size (mm)	Specification (mm)	Article No.	Price
350	1200x350	HW(G).111	₹ 8770/-



Wardrobe Sliding Fitting

In-line Wardrobe Fitting (inline Soft Close)



Article No.

HWSF.10.1.8

Price:-₹ 102795/-

Article No.

HWSF.10.2.4

Price:-₹ 114345/-

Length : 1.8meter

Application : Manual

2 Door Fitting

Length : 2.4meter

Application : Manual

2 Door Fitting

Technical Points:

- Applied to Wooden door, Aluminium-framed door, etc.
- Max loading capacity: 50kg./Door
- Door thickness: 18~28mm
- Door width: 900~1200mm
- Door height: 600mm~2800mm

Installation Video Link:

<https://youtu.be/rAdsMM-melM>

Up Track	1pcs/set.		
Bottom Track	1pcs/set.		
Hydraulic damper		2pcs/set.	
2-D regulator		2pcs/set.	
Bottom Fittings		2pair/set.	
		2pair/set.	

External Soft-Close Wardrobe Fitting (Top Line 22 - Soft Close)

- 2 Door fitting Set.
- Two-way damping device: Damping function exists while door opening and door closing.
- Smooth, steady and silent, movement;
- Anti - slipping-off mechanism to prevent door panel skipping out of track and ensure a secure functionality.
- Door height and gap between doors adjustable (suitable for door thickness: 18~40mm)
- Reinforced structure design with maximum weight capacity 50kgs per door.

Technical Points

- Applied to Wooden door, framed door,
- Aluminium-framed door, etc.
- Max loading capacity: 50kg.
- Door thickness: 18~28mm

Article No. HWSF.20 A Inner Door Fitting

Price-₹ 8665/-

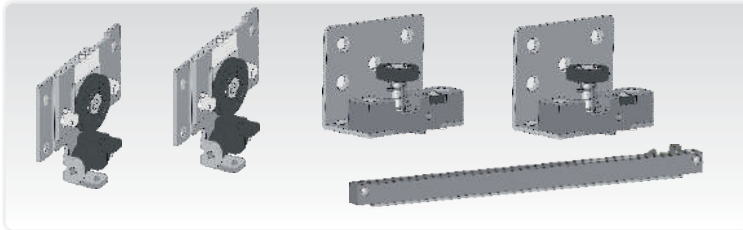

Top Profile Price-₹ 2605/-

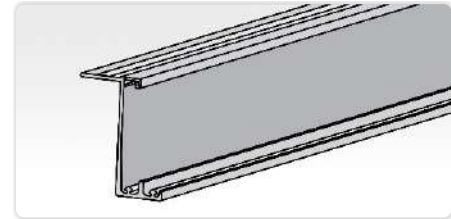

Bottom Profile Price-₹ 2605/-

Article No. HWSF.20C 10 Feet

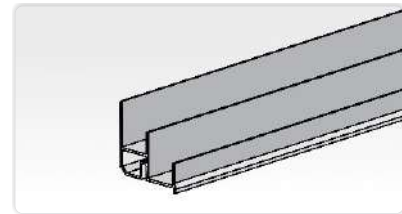

Article No. HWSF.20 B Outer Door Fitting

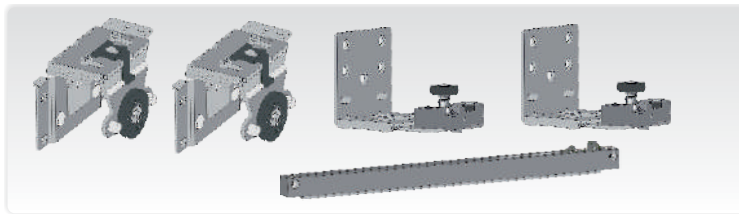

Soft Close Sliding Fitting (Brush Roller)

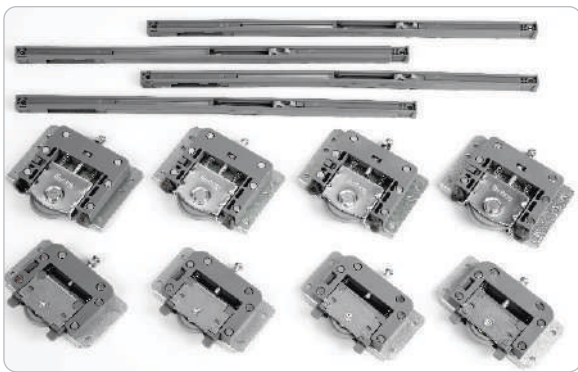

Top Track

Bottom Track
(with Cover Plate)

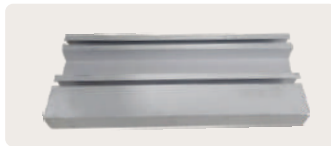

Specification:-

- Suitable wooden Door Thickness 16-22mm
- Weight Capacity 60kg

Installation Video Link:

<https://youtu.be/sB711QmZQ8M>

Article No.

HWSF.60.11D

HWSF.60.10D

08 Ft. - Price -₹ 2850/-

Price -₹ 2800/- Set of 2 Door

13 Ft. - Price -₹ 4600/-



Top Track

Bottom Track
(with Cover Plate)

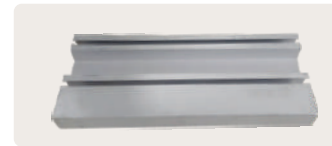

Specification:-

- Specific for Profile 45mm
- Suitable wooden Door Thickness upto 25mm
- Weight Capacity 70kg

Article No.

HWSF.60.11D

HWSF.80.10D

08 Ft. - Price -₹ 2850/-

Price -₹ 3000/- Set of 2 Door

13 Ft. - Price -₹ 4600/-





Hardwyn India Limited

B- 101, Mayapuri Inds. Area, Phase - 1
New Delhi - 110064
Customer Care No. +91-9212373715
Email: info@hardwyn.com

An ISO 9001: 2015 Company

Experience Centre

New Delhi
2/69, WHS, Kirti Nagar
New Delhi - 110015
Ph.: 011-41054792

 [linkedin.com/hardwyngroup](https://www.linkedin.com/hardwyngroup)
 [facebook.com/HardwynGroupofficial](https://www.facebook.com/HardwynGroupofficial)
 [instagram.com/hardwyngroup](https://www.instagram.com/hardwyngroup)
www.hardwyn.com